



Aeon AcousticPro UHD Series

EDGE FREE® Fixed Frame Sound Transparent Projection Screen









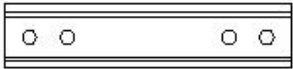
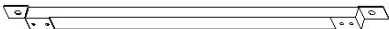

User's Guide

Product Description: The Aeon *AcousticPro UHD* Series is a fixed frame projection screen that uses Elite's EDGE FREE® technology. The EDGE FREE® design resembles a giant size flat panel TV display. The Aeon includes **Edge trim** as an installation option to further enhance the frame appearance and absorb projector overshoot. An optional LED backlighting kit is available for added visual appearance.

For more information on the LED kit please visit: <http://www.elitescreens.com/led>

Hardware and Parts List

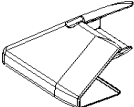
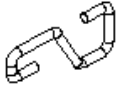
Please make sure all parts listed below are included before installation.

<p>A. Elbow joint x 4 pcs</p> 	<p>B. Top/Bottom horizontal fame x 4 pcs</p> 	<p>C. Left/Right vertical frame x 2 pcs</p> 
<p>D. Center joints x 2 pcs</p> 	<p>E. Center Support bar x 1-2 pcs</p> 	<p>F. Wall brackets x2-3 pcs</p> 
<p>G. M5x50 screws and anchor x 6 pcs</p> 	<p>H. M5x15 screw x 24 pcs</p> 	<p>I. Black Tape x 1 bag</p> 
<p>J. Edge trim x6 pcs</p> 	<p>K. Plastic corner sleeve x 4 pcs</p> 	<p>L. Hook</p> 
<p>M. Fiberglass rod x 6 pcs & Plastic sleeve x 12 pcs</p> 		

Frame Assembly

1. Insert the center joint into one of the $\frac{1}{2}$ *horizontal frames (B)* and fasten it with the two *M5x15 screws (H)*.
2. Insert the other $\frac{1}{2}$ horizontal frame piece to the center joint and fasten also using two *M5x15 screws*.
3. Repeat steps 1 and 2 for assembling the second horizontal frame.

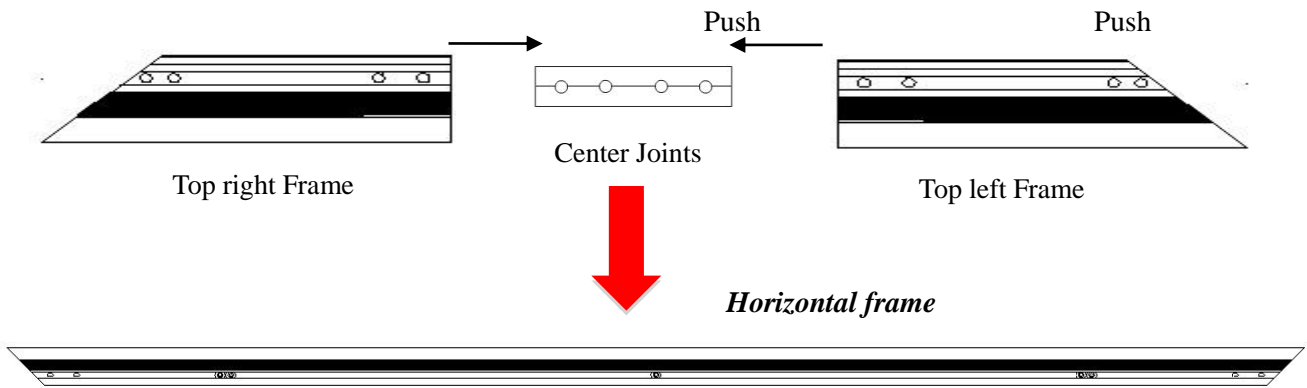

4. Insert the *elbow joint (A)* into each end of the *horizontal frames (B)* as shown below.

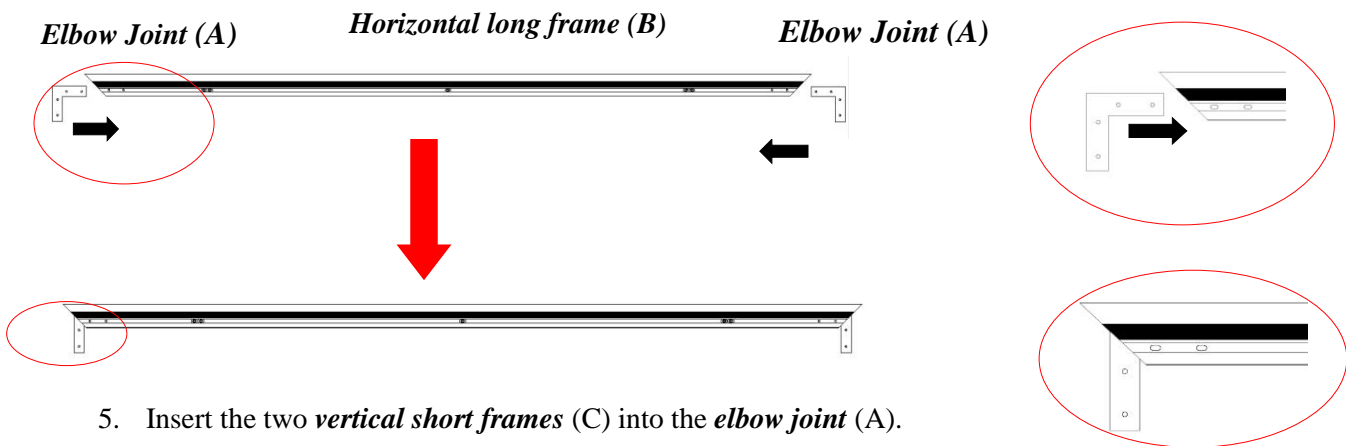

5. Insert the two *vertical short frames (C)* into the *elbow joint (A)*.

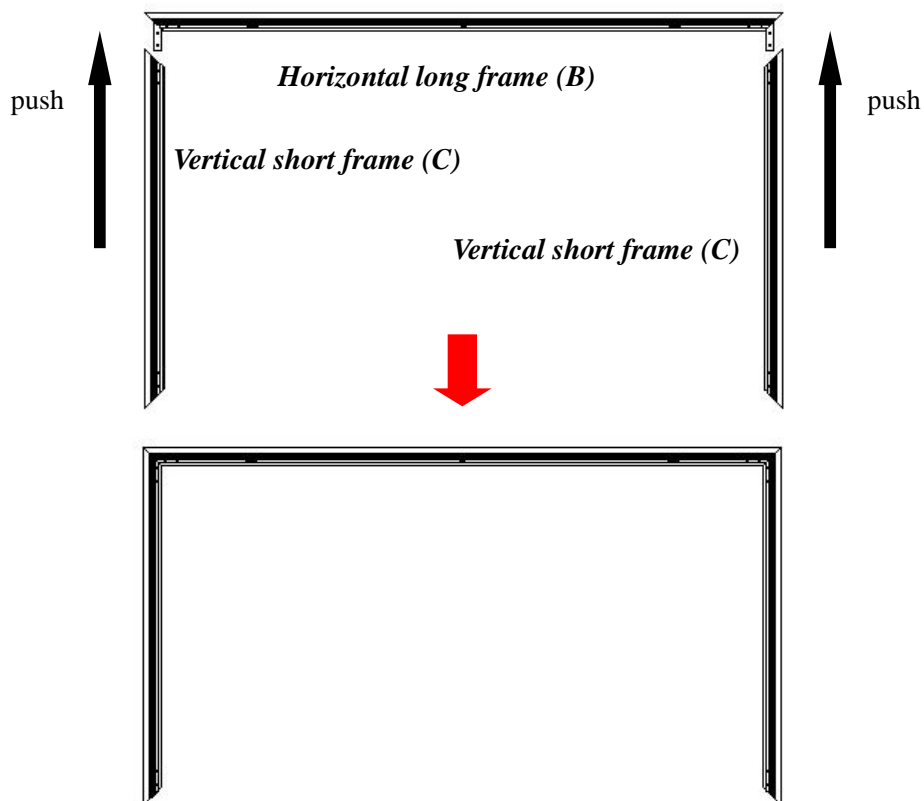

6. Join the remaining *horizontal long frame (B)* with the frame built in the previous steps as shown below.

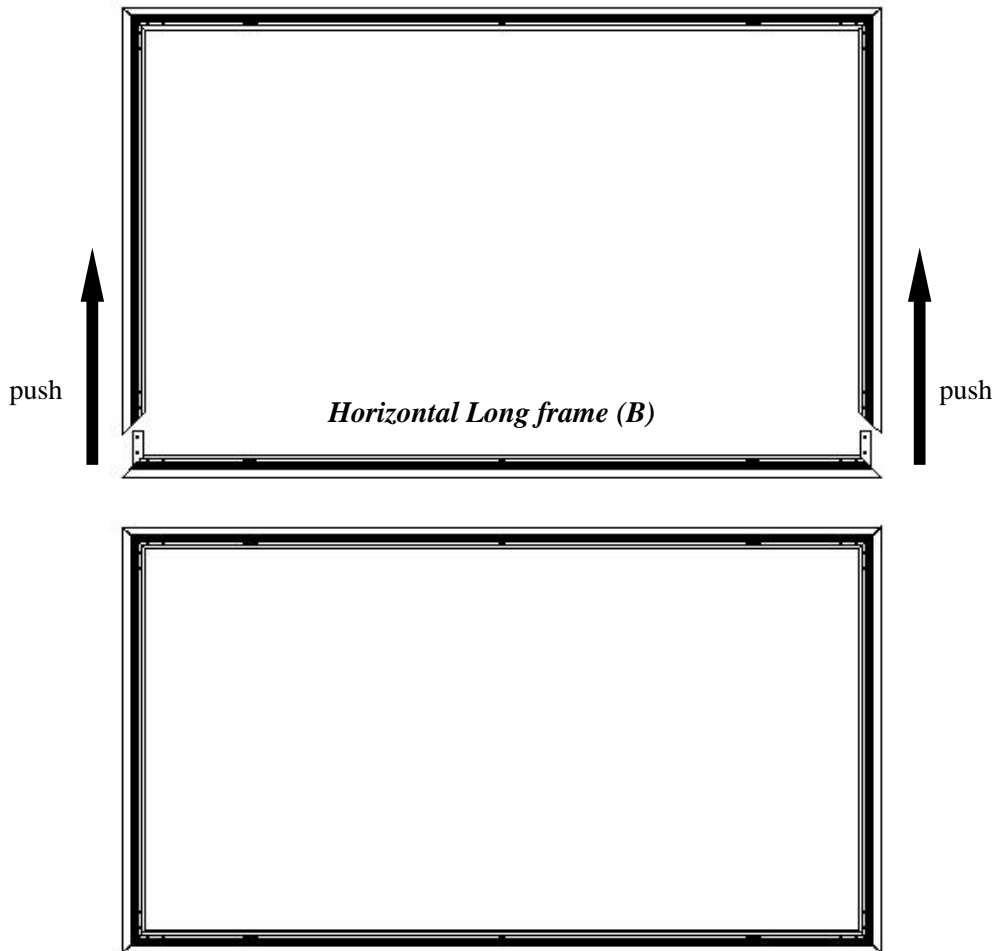

7. Make sure all four corners are properly in place to form a perfect square. Then fasten the four angles with the *M5x15 Screws (H)*.

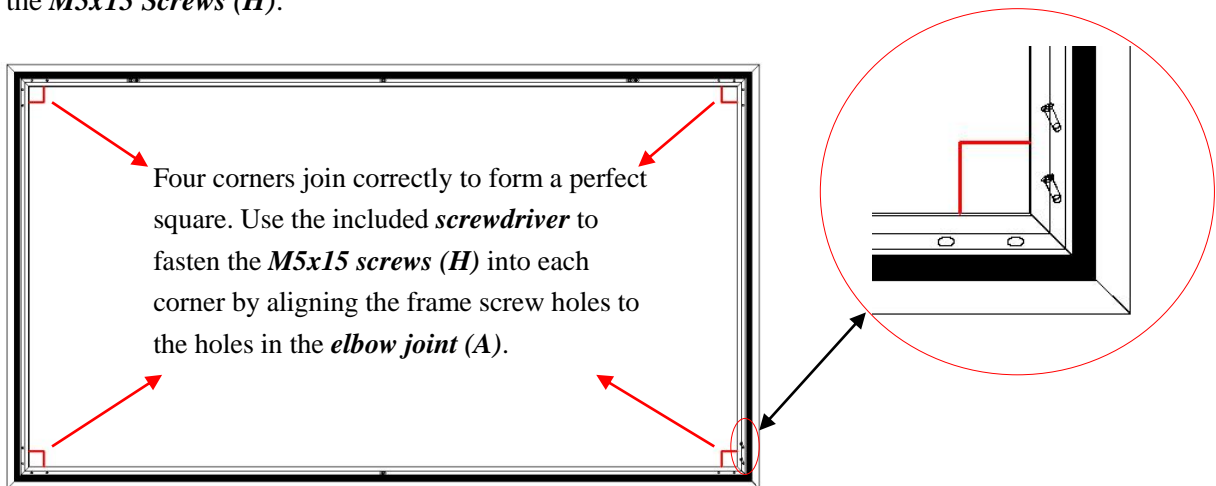

Screen Material Installation

1. Lay the *screen material* completely flat with the front facing down on a clean surface in a horizontal position. The back side of the screen material should be placed upwards.

Note: The back side of the material has the velcro borders all around the edges.

2. Carefully and gently place the assembled frame on top of the screen material as shown below. Make sure to not allow the angle edge of the frame to come in direct contact with the screen material to avoid puncturing it.

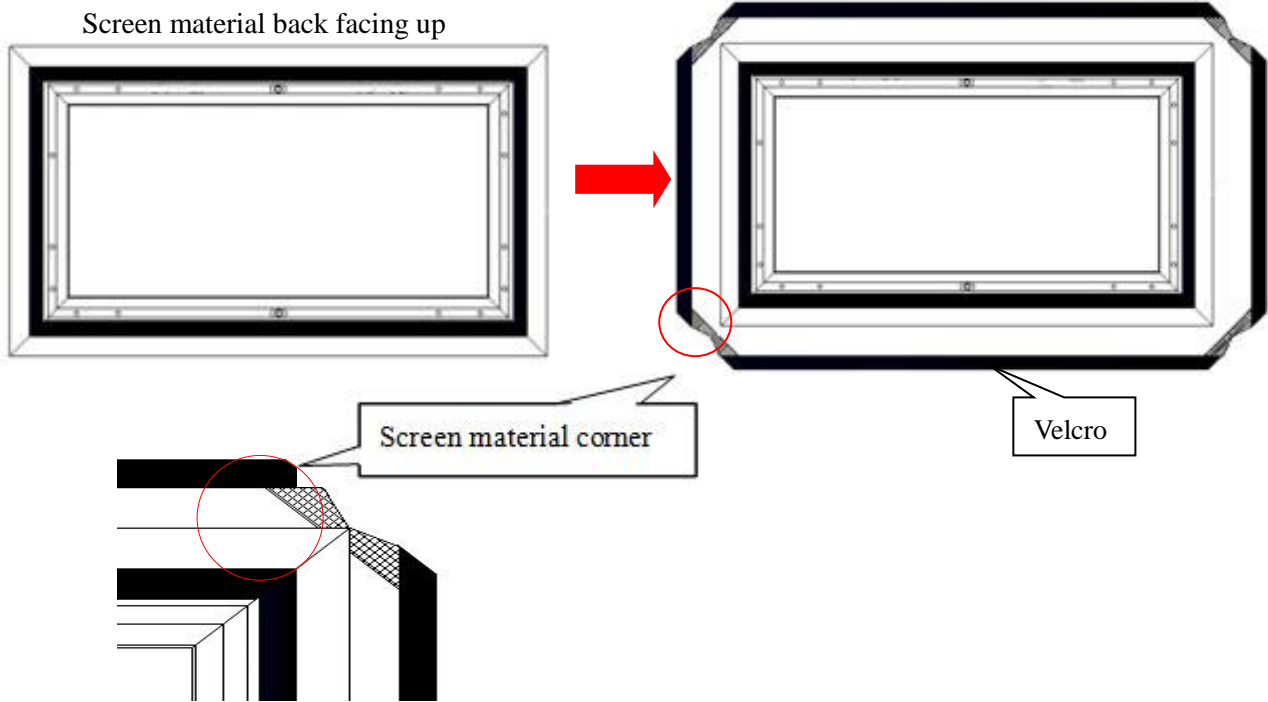

3. After all of the corners of the frame have been properly aligned, attach the material to the frame in the following order A→B→C→D (see instructions below for details).

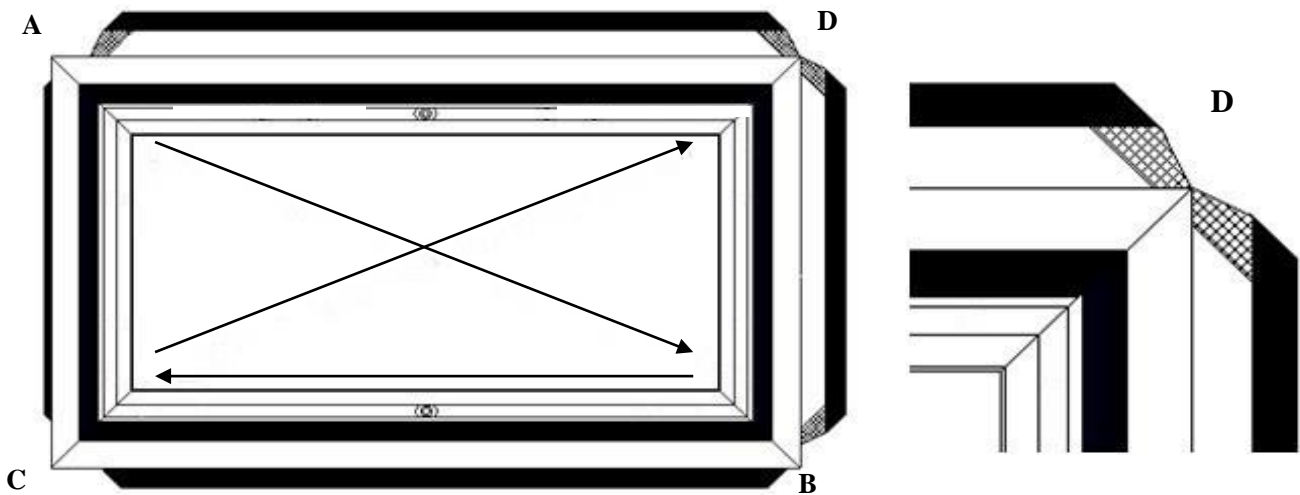

Attach the screen material to the corners as shown below.

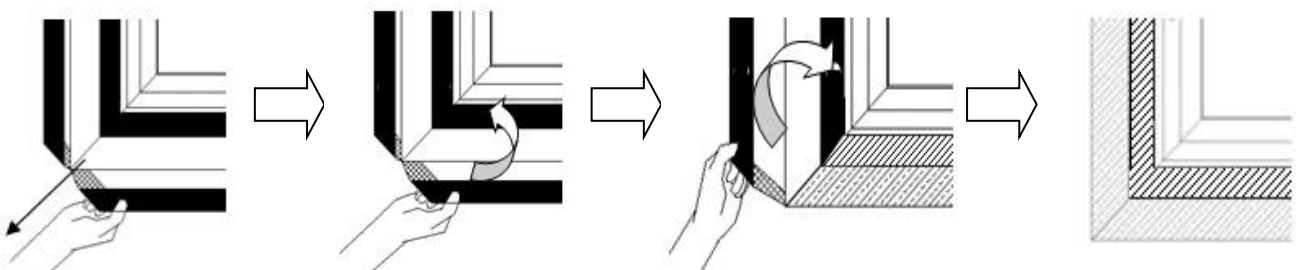

1) Stretch the screen material in the direction of the arrowhead.

2) Fold over and attach material to the velcro strip of the frame.

3) Fold over second side and attach to frame

4) Repeat until all four sides are done in the order A, B, C, D

4. After all four corners have been attached; please check whether the frame corners are wrapped by the screen material. If not, please loosen the velcro connection and repeat the above steps so the frame is not exposed.

Note:
Represents the
screen material

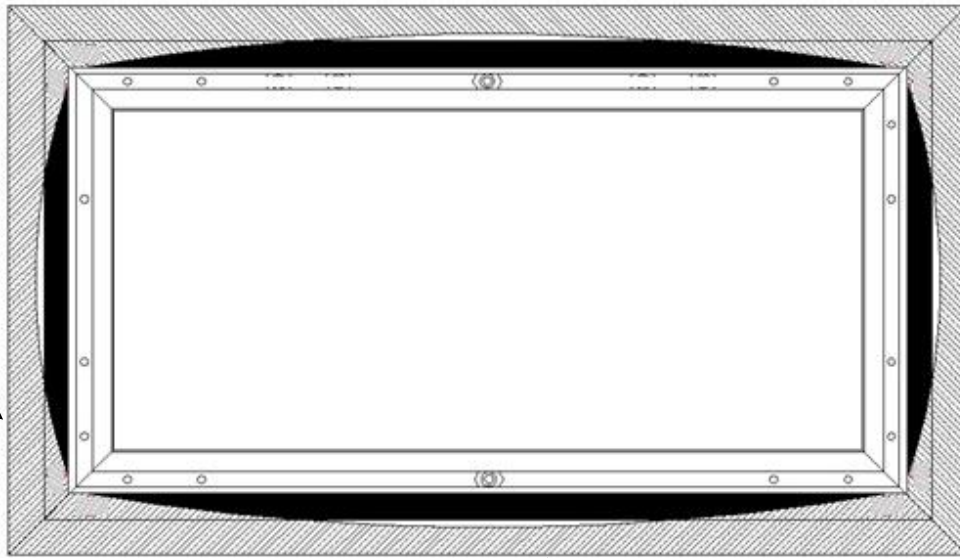

Note: The black shaded part represents the velcro on the frame. That Velcro end will ultimately attach with the other velcro end on the screen material.

5. Proceed to attach the rest of the material to the frame as described in the illustrations below.

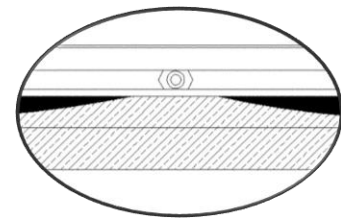
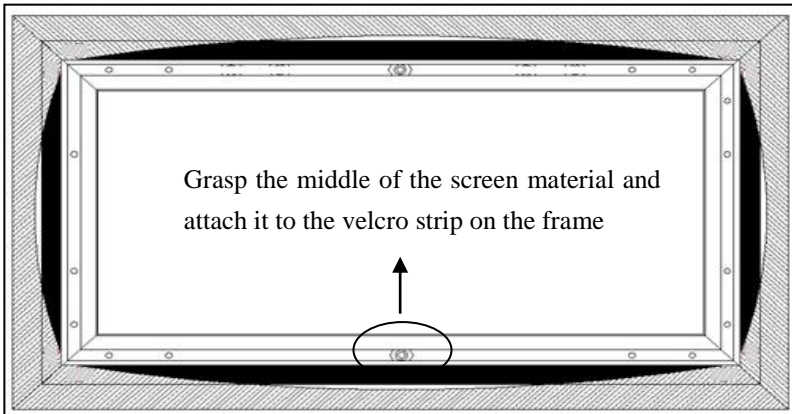

Lay the Velcro end on the screen material over the Velcro end of the frame and keep it within the edge.

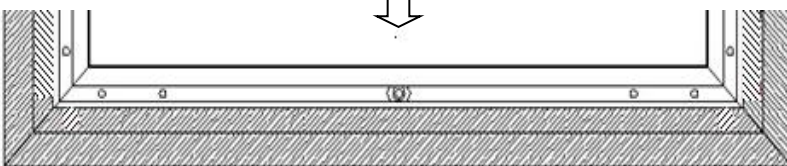
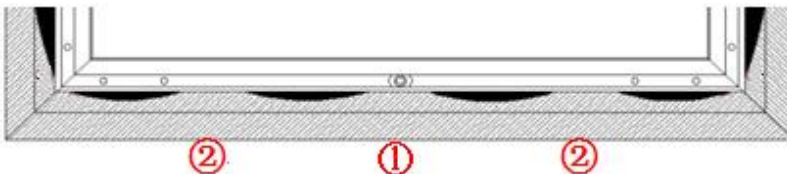
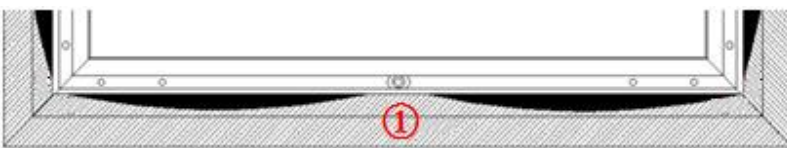

Proceed in the following sequence below ①→②

The key is to attach within the middle sections of 1 and 2. Then continue attaching the remaining unattached areas.

Repeat the same steps on the remaining three sides in the sequence A, B, C, and D as shown below.

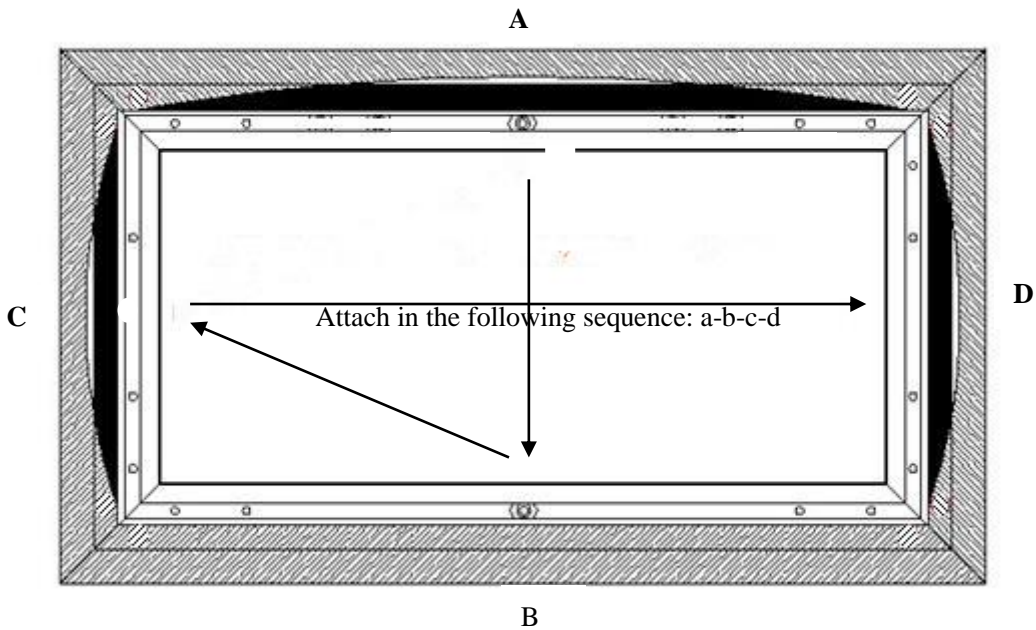

Screen Material Removal

Follow the steps to properly remove the screen material from the frame. This procedure will ensure prolonging the life of the screen material.

1. Detach the velcro from the frame.
2. Gently pull back the material to release the material from the velcro connections on the corners.

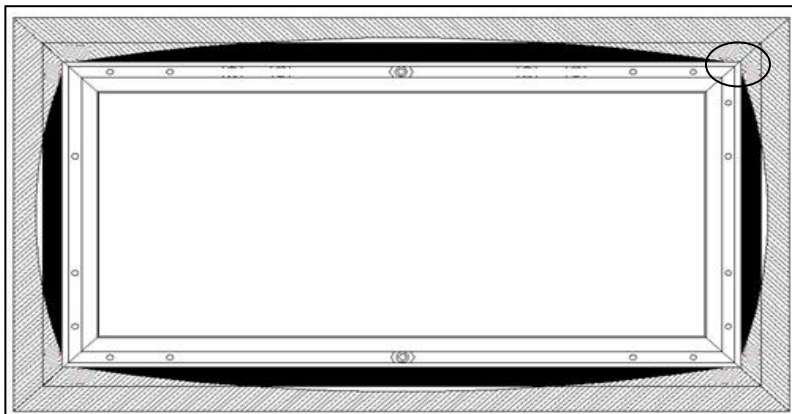

Pull back the screen material from the velcro connection along the edges of the frame to detach it.

Support bar installation (for models under 135")

1. Position the *center support bar (E)* in the middle of the frame and align the hole on each end of the support bar with the *M6 hex screws* on the top and bottom frames. Then fasten with the *M6x12 screws*.

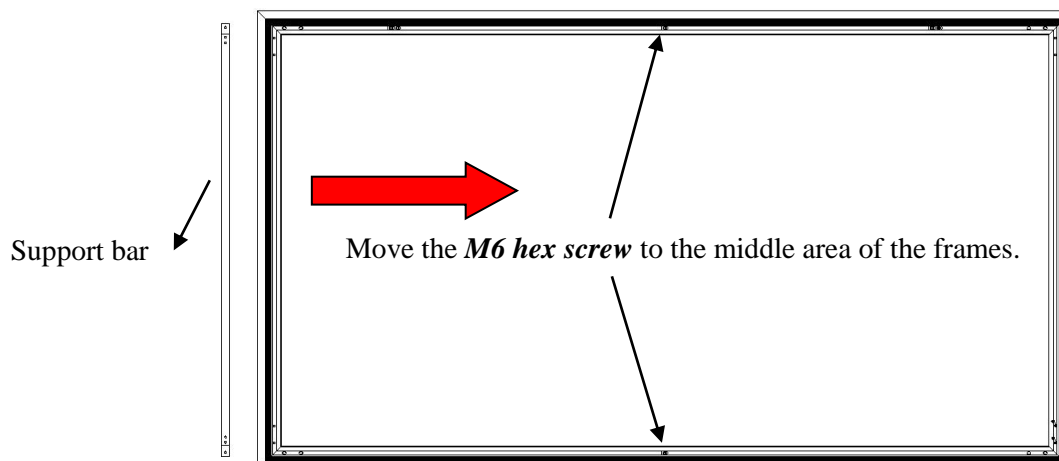

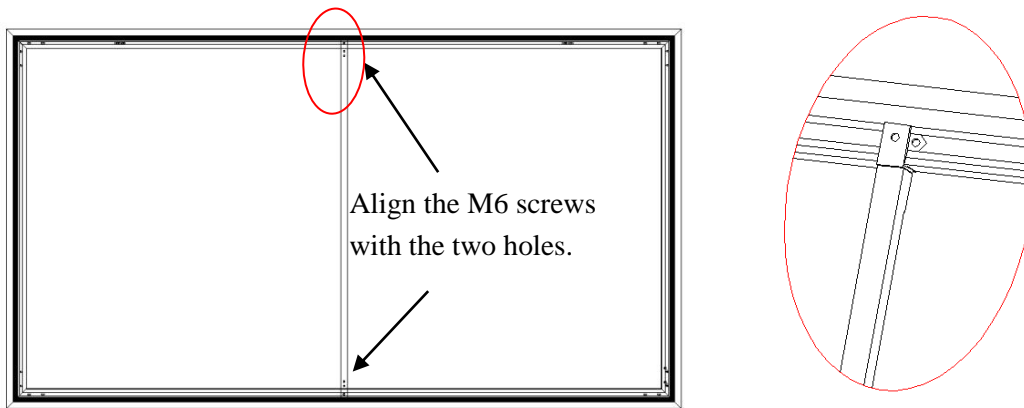

Support bar installation (for models 135" and above)

1. Position the *center support bar (E)* to the area of the frame shown in figure 1. Align the hole on each end of the support bar with the *M6 hex screws* on the top and bottom frames. Then fasten with the *M6x12 screws*.

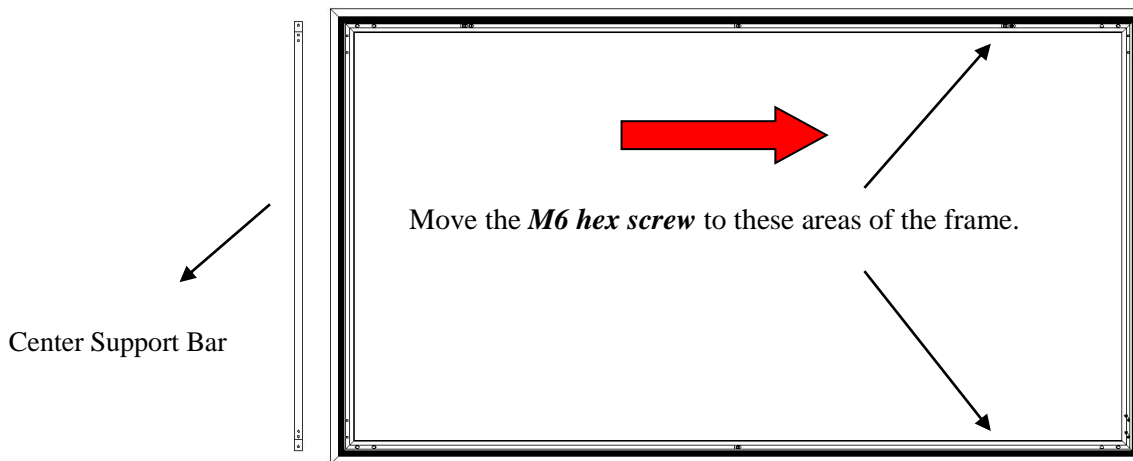
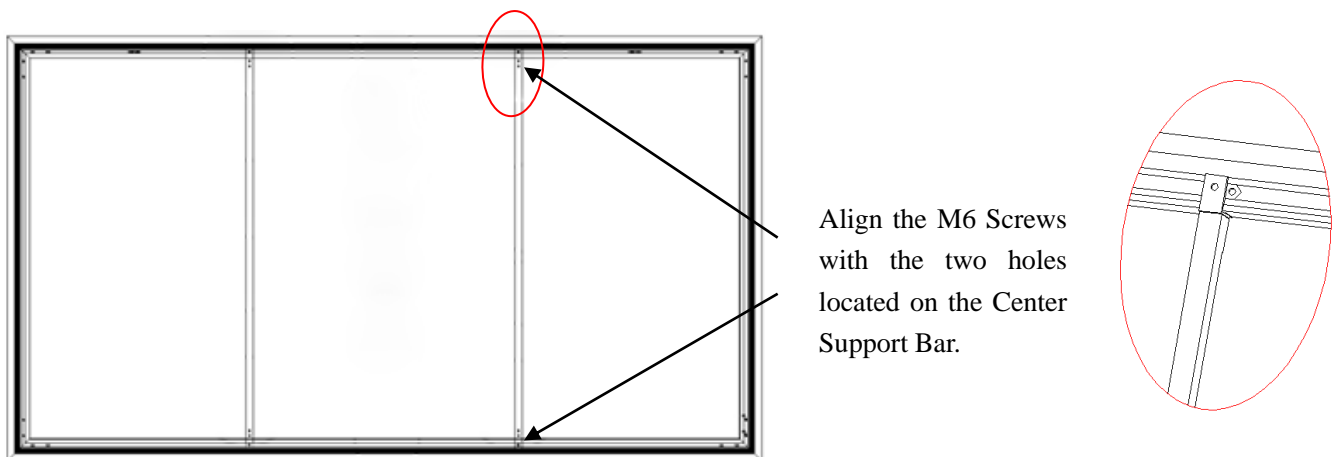
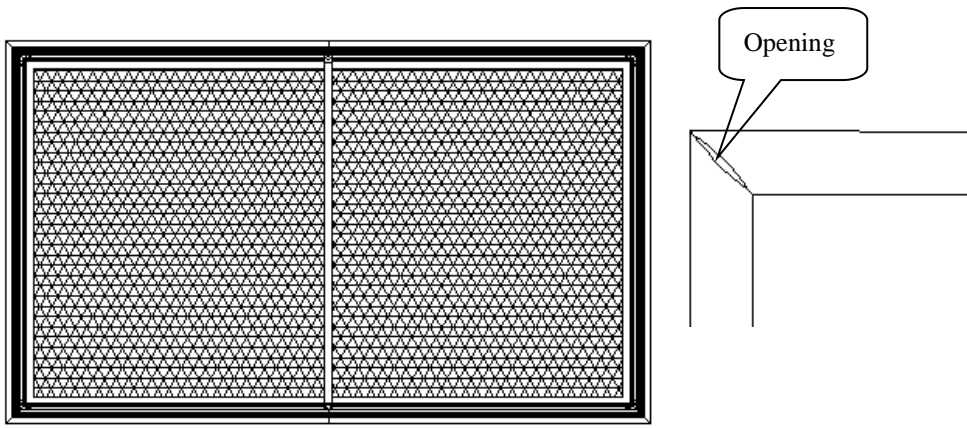

Figure 1



Black Backing Installation

1. Lay the Black backing completely flat with the opening side facing down on the white (AcousticPro UHD) material in a horizontal position under the center support bar.



2. Put the plastic sleeves on the fiberglass rods.

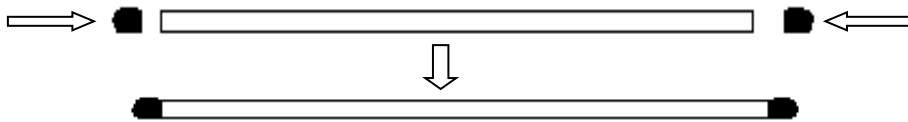

3. Insert *the fiberglass rods (M)* through the openings. The longer rods are used on the vertical edges of the screen material, and the shorter rods are used on the horizontal edges, as shown below.

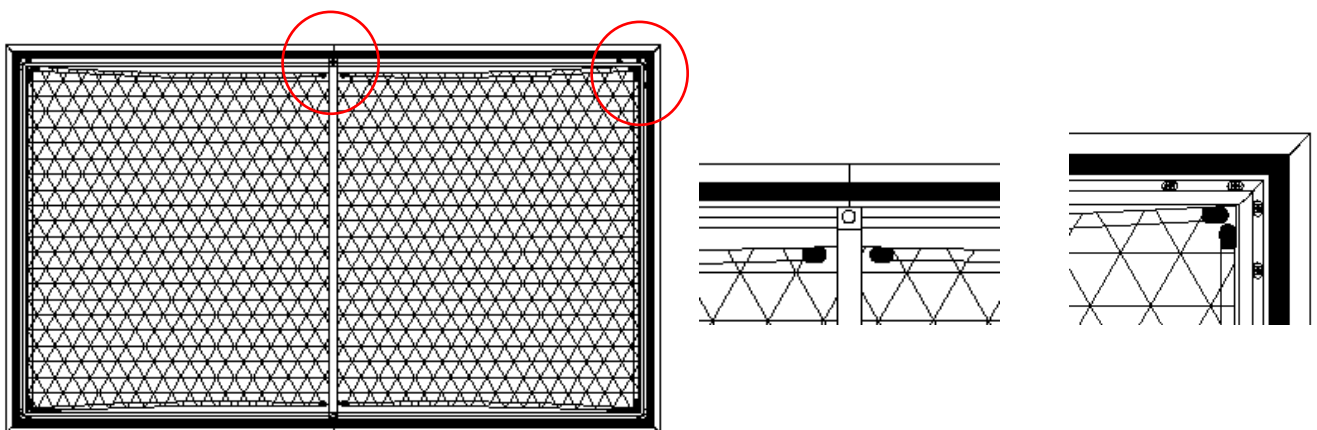
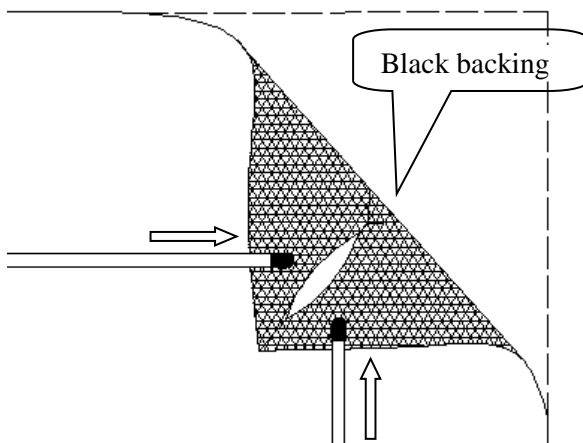

4. Hook installation

- 1) Follow steps 1, 2, 3 on Fig. 1 to properly affix the hook to the frame as shown in Fig. 2.
- 2) Affix the hooks on the red arrow marks (Fig. 3).

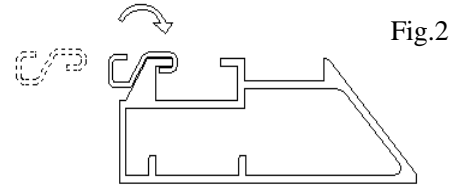
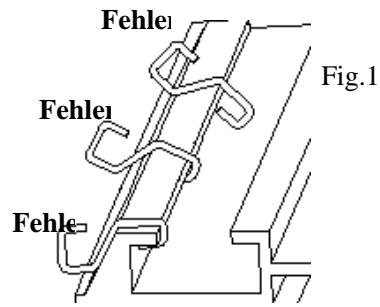
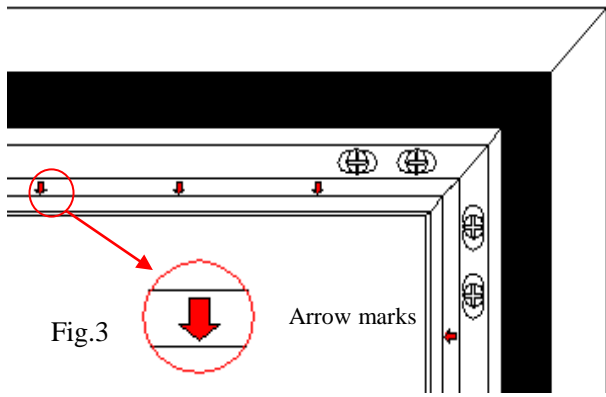

Example of properly affixed hook to frame.

NOTE: Make sure the hooks are affixed correctly as they are not easy to remove from the black mesh backing once they have been affixed.

5. Black backing material attachment into the hooks.

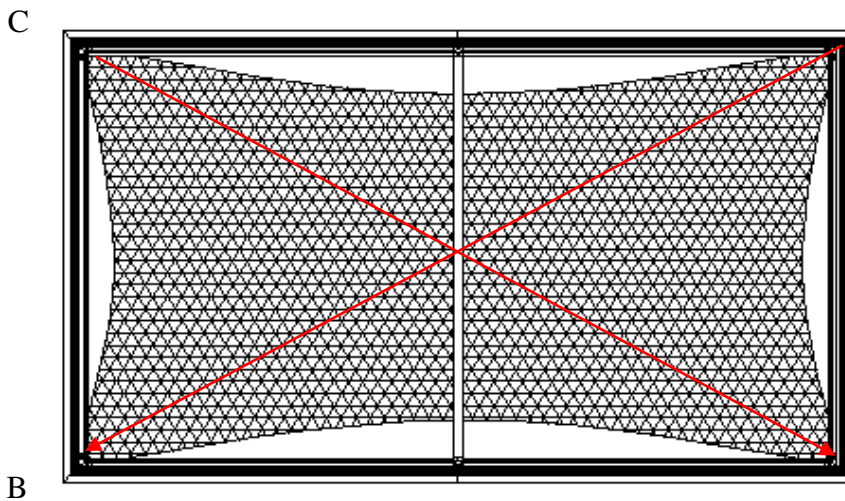
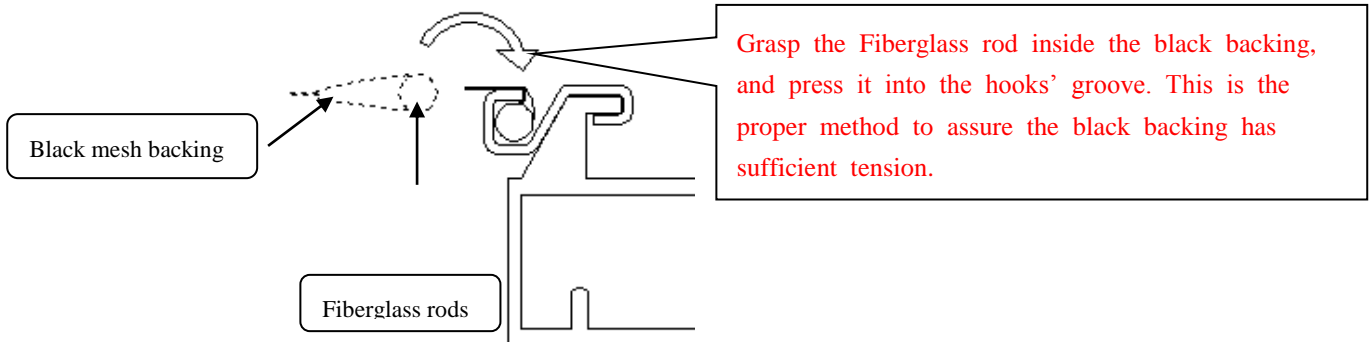

A

First, stretch the four corners of the black backing and insert into the first two hooks on each corner in the following sequence A → B → C → D.



D

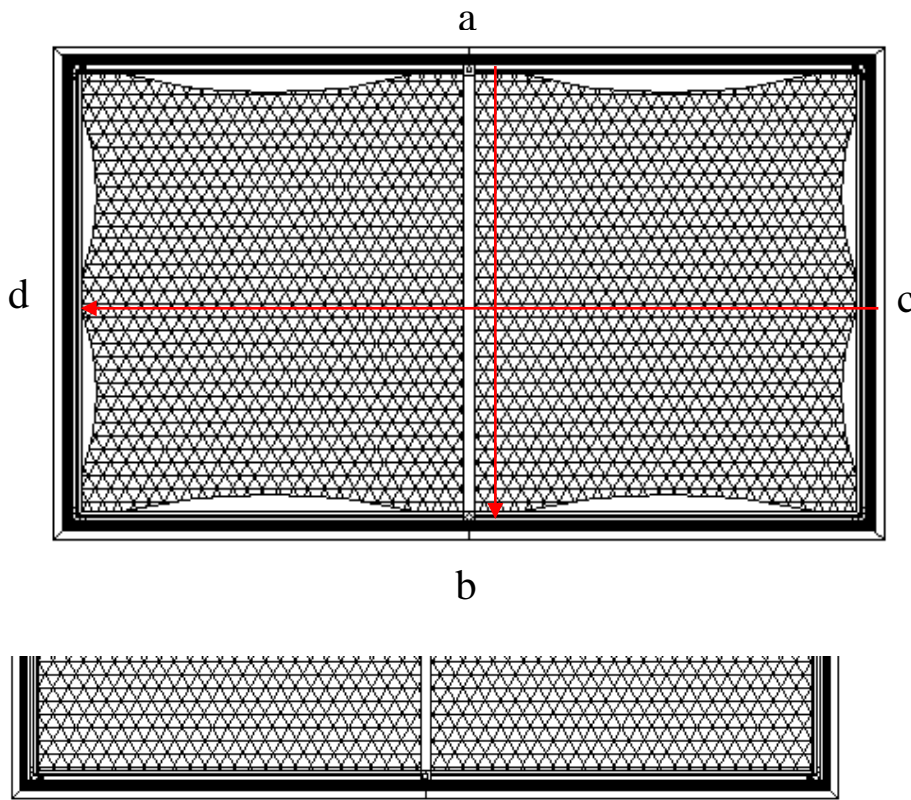

Next, stretch the black backing and affix to the hooks from the middle in the following sequence a→b→c→d

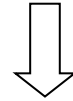

Lastly, affix the black backing to the remaining hooks. Add more hooks as needed to achieve flatter results in the areas that are not flat.

Edge trim Installation

The Aeon fixed screen is EDGE FREE®, but you may install the Edge trim to provide it with an elegant thin bezel finish.

Edge trim x 6 pcs



Plastic corner sleeve x4pcs

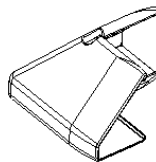

Black tape x1bag



1. Place the assembled frame on a flat and clean surface. The projection screen surface should be facing up.
 - a. As an option, Black Tape is supplied to cover any possible gaps between the pieces of the bezel trim. Align the tape with the edge of the screen, as shown in Figure 1. Once properly aligned, apply the black tape to the center of the top and bottom of the screen material.

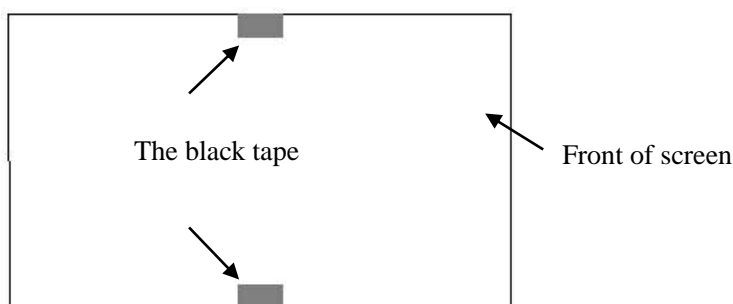
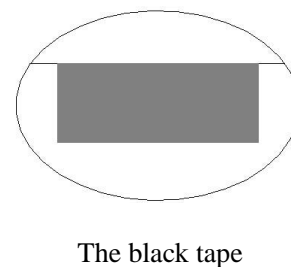
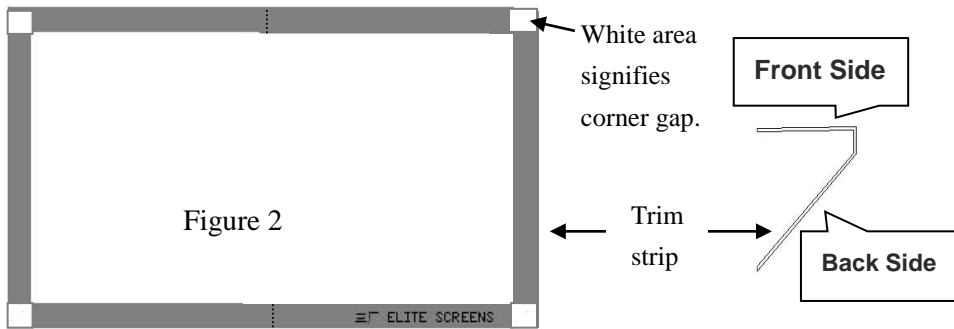

Figure 1



The black tape

2. Without removing the adhesive tape, place all the trim pieces along the edge of screen material. Adjust the trim so that the top and bottom trim pieces are touching and show no gaps in the center. (Note: The Elite logo should be positioned on the bottom right). Refer to Figure 2 below for a visual reference.



TIP:
Align the trim starting from the center to reduce gapping. Any gaps left at the corners will be covered by the corner sleeves.

NOTE: Make sure the bottom edge trim with the Elite Screens logo is installed on the correct side. The back of the material should be labeled with a DOWN sticker to indicate the material is facing in the down position. The Elite Screens logo should be installed on the DOWN side

3. After properly aligning all trim pieces, carefully remove trim piece A (see Figure 3 below). Remove the inside backing of the tape and place the trim piece in its original position on the frame. Repeat this step for the remaining trim pieces in the following order: B-C-D-E-F.

The **front side** of the frame with trim pieces attached.

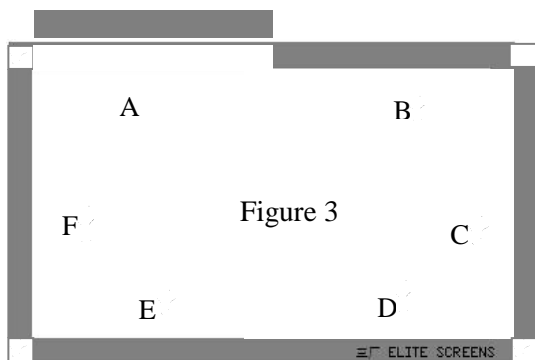

4. After the bezel trim has been installed, place a **corner sleeve (K)** on all four corners. Begin by aligning and adjusting the corner sleeve through the front of the screen. Make sure the corner sleeve completely wraps the edge of the bezel trim. This should cover any corner gaps.

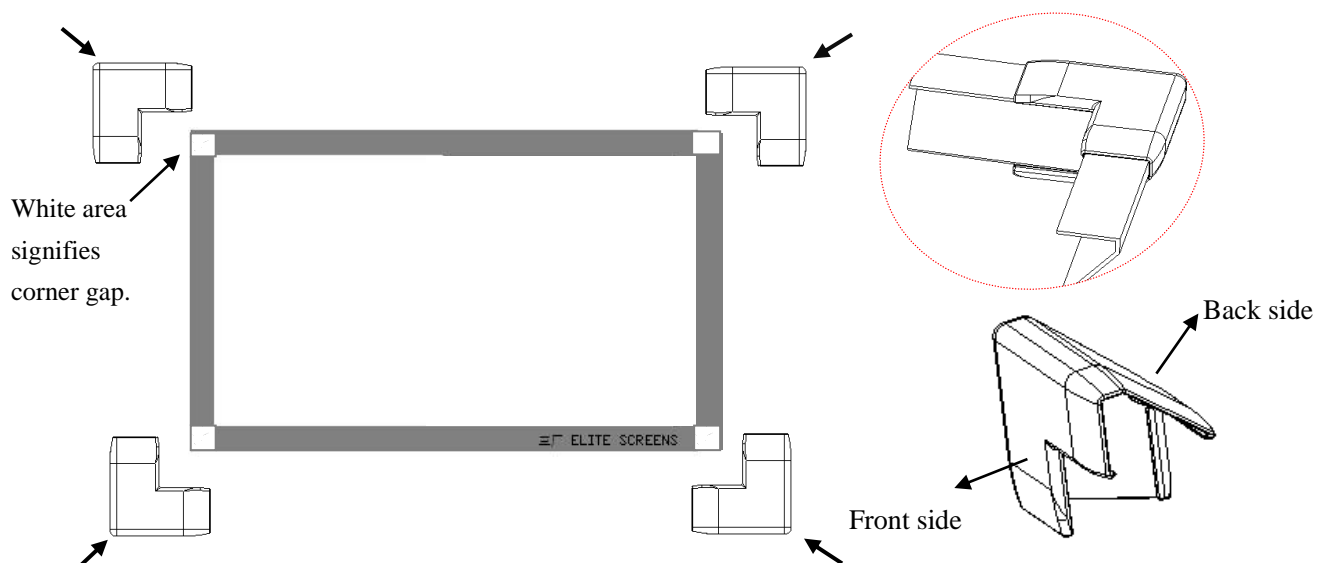

Once all corner sleeves have been snapped into each corner of the frame, it is ready to be installed.

Attention: Installing the edge trim will reduce the viewing size of your screen. See below illustrations for a comparison of the viewing size of the before and after edge trim installation using the 100" & 120" 16:9 diagonal models.

100" comparison:

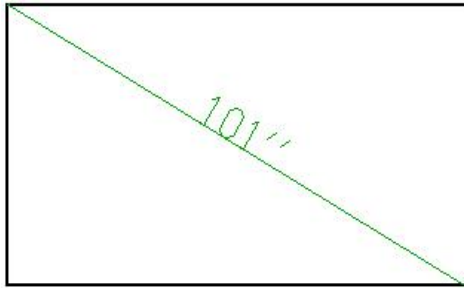

Before installing the edge trim

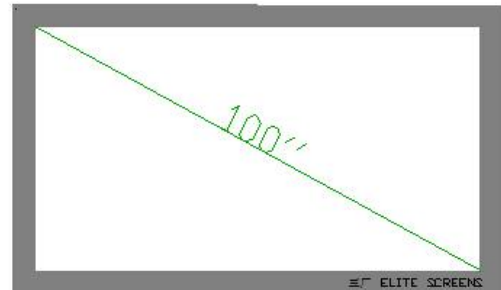

After installing the edge trim

120" comparison:

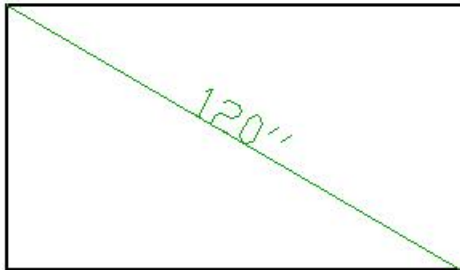

Before installing the edge trim

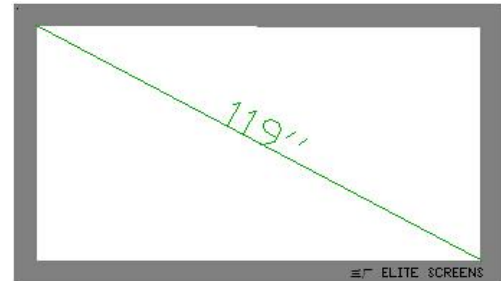

After installing the edge trim

Installation

Locate your desired installation location with a stud finder (recommended) and mark the drill-hole area of where the screen is to be installed.

1. Drill a hole with the proper bit size according to the wood screws included.
2. Line up the wall brackets with the drilled holes on the installation location and screw them in using a Phillips screwdriver.
3. Position the frame screen onto the *wall brackets (F)* as shown in **below**.
4. The design of the wall brackets allows the frame to slide over them through its sides. This is an important feature of the installation design as it allows your screen to be properly centered.

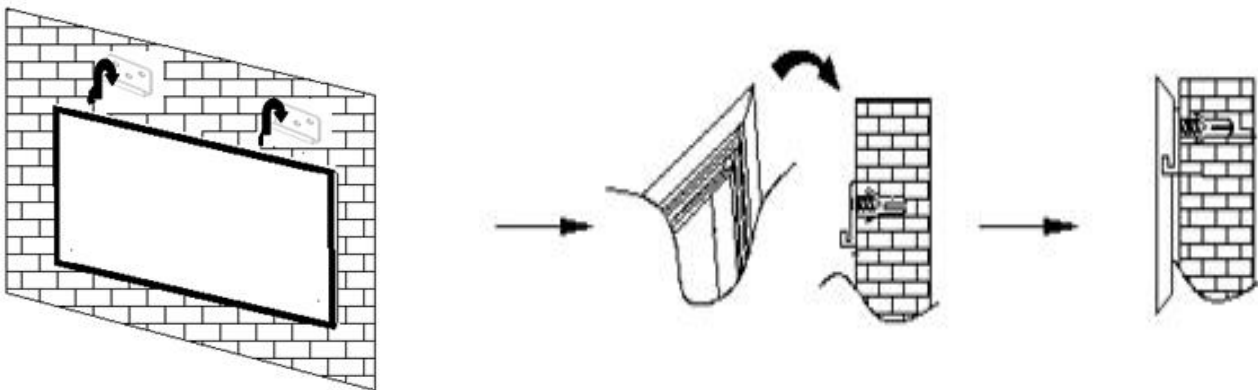

For a local Elite Screens contact or Technical Support, please visit

www.elitescreens.com